

**CONTENITORI
INDUSTRIALI
IN PLASTICA**

INDICE

Grandi contenitori	pag.4
Contenitori multiuso	pag.17

GRANDI CONTENITORI

Qualità e resistenza alla grande

LARGE CONTAINERS

Quality and resistance on the large scale

I Cargopallet, progettati per carichi rilevanti, sono resistenti e indeformabili, hanno colonne di rinforzo e fondo nervato. Inerti a contatto di acidi, idrocarburi e solventi.

The Cargopallet, designed for large loads, are resistant and non-deformable, have reinforcement pilasters and ribbed base. They are inert to acids, hydrocarbons and solvents.



Cargopallet 700

Cargopallet 600 / 300

**Cargopallet Prodotti Pe
300 / 600 / 700**

Cargopallet 1100 / 1300

Cargopallet 280

Accessori

Cargo Fold 700

700 PLUS

Questo Cargopallet soddisfa le richieste del mercato europeo. 24 versioni: con 4 piedi, 2 o 3 travette, con ruote, con portello, ATX, IND, ortofrutticolo.

This version fulfils the European market needs. 24 versions: with 4 feet, 2 or 3 runners, wheels, folding door ATX, IND, fruit and vegetables.

Cargopallet 700 Plus



Codice Prodotto









-  **80 124 801 / 4 piedi**
-  **80 124 802 / 2 travette**
-  **80 124 803 / 3 travette**
-  **80 124 804 / 4 ruote**
-  **80 124 821 / 4 piedi**
-  **80 124 822 / 2 travette**
-  **80 124 823 / 3 travette**
-  **80 124 824 / 4 ruote**
-  **Prodotto Personalizzabile**



Cargopallet 700 Plus con Portello



Codice Prodotto

-  **80 124 811 / 4 piedi**
-  **80 124 812 / 2 travette**
-  **80 124 813 / 3 travette**
-  **80 124 814 / 4 ruote**
-  **80 124 831 / 4 piedi**
-  **80 124 832 / 2 travette**
-  **80 124 833 / 3 travette**
-  **80 124 834 / 4 ruote**
-  **Prodotto Personalizzabile**



Dati Tecnici

* Dimensioni del portello 782x40xh326

Dim. esterne	Dim. interne	Dim. est. con ruote	Peso	Incasto impilabilità	Luce tra i piedi	Altezza dei piedi	Capacità max	Portata max	Portata max in sovrapp.
1200x 1000x h830	1120x 920x h655	1200x 1000x h870	31,8 Kg (80 124 801)	20	lato corto 800 lato lungo 830	120	680 dm ³	600 kg	4000 kg

Cargopallet 700 Plus Grigliato



Codice Prodotto

-  **80 124 851** / 4 piedi
-  **80 124 852** / 2 travette
-  **80 124 853** / 3 travette
-  **80 124 854** / 4 ruote
-  **Prodotto Personalizzabile**



Cargopallet 700 Plus Grigliato con Portello

VENDITA LEGATA A QUANTITATIVI MINIMI



Codice Prodotto

-  **80 124 861** / 4 piedi
-  **80 124 862** / 2 travette
-  **80 124 863** / 3 travette
-  **80 124 864** / 4 ruote
-  **Prodotto Personalizzabile**



Dati Tecnici

* Dimensioni del portello 782x40xh326

Dim. esterne	Dim. interne	Dim. est. con ruote	Peso	Incasso impilabilità	Luce tra i piedi	Altezza dei piedi	Capacità max	Portata max	Portata max in sovrapp.
1200x 1000x h830	1120x 920x h655	1200x 1000x h870	31,2 Kg (80 124 851)	20	lato corto 800 lato lungo 830	120	680 dm ³	600 kg	4000 kg

600 NEW / 300 PLUS

I contenitori 600 New sono ancora più robusti grazie all'elevato irrigidimento delle pareti. Disponibili con piedini, travette o ruote.

These 600 New containers are sturdy and reliable. The interior walls are smooth. Available with feet, runners or wheels.

Cargopallet 600 Plus New



Codice Prodotto

- 30 185 740 N / 4 piedi
- 30 185 763 N / 2 travette
- 30 185 807 N / 3 travette
- 30 185 770 N / 4 travette
- 30 185 748 N / 4 ruote angoli
- 30 124 803 N / 4 ruote centro
- 30 185 778 N / 4 ruote angoli plt arancio
- 30 185 805 N / 4 ruote centro plt arancio
- 30 185 745 N / 2 travette e 4 ruote
- 30 185 753 N / 4 piedi
- 30 185 764 N / 2 travette
- 30 185 808 N / 3 travette
- 30 185 771 N / 4 travette
- 30 185 776 N / 4 ruote angoli
- 30 185 804 N / 4 ruote centro
- 30 185 777 N / 4 ruote angoli plt arancio
- 30 185 806 N / 4 ruote centro plt arancio
- 30 185 746 N / 2 travette e 4 ruote



● Prodotto Personalizzabile

Cargopallet 600 Plus New con Portello



Codice Prodotto

- 80 124 502 N / 4 piedi
- 80 124 503 N / 2 travette
- 80 124 516 N / 3 travette
- 80 124 506 N / 4 travette
- 80 124 504 N / 4 ruote angoli
- 80 124 514 N / 4 ruote centro
- 80 124 505 N / 2 travette e 4 ruote
- 80 124 552 N / 4 piedi
- 80 124 553 N / 2 travette
- 80 124 517 N / 3 travette
- 80 124 557 N / 4 travette
- 80 124 554 N / 4 ruote angoli
- 80 124 564 N / 4 ruote centro
- 80 124 555 N / 2 travette e 4 ruote



● Prodotto Personalizzabile

Dati Tecnici

Cargopallet 600 Plus/Grigliato/con Portello

* Dimensioni del portello 782x40xh326

Dim. esterne	Dim. interne	Dim. est. con ruote al centro	Dim. est. con ruote ali angoli	Peso	Incasso impilabilità	Luce tra i piedi	Altezza dei piedi	Capacità max	Portata max	Portata max in sovrapp.
1200x800xh850	1130x725xh690	1200x800xh900	1200x800xh1000	25,2 Kg (30 185 740 N)	35	lato corto 600 lato lungo 830	120	550 dm ³	500 kg	2000 kg

Cargopallet 600 Plus Grigliato



Codice Prodotto

-  **80 124 340** / 4 piedi
 -  **80 124 341** / 2 travette
 -  **80 124 351** / 4 travette
 -  **80 124 342** / 4 ruote
 -  **80 124 347** / 4 ruote
plt arancio
 -  **80 124 348** / 2 travette
e 4 ruote
 -  **80 124 360** / 4 piedi
 -  **80 124 361** / 2 travette
 -  **80 124 371** / 4 travette
 -  **80 124 362** / 4 ruote
 -  **80 124 367** / 4 ruote
plt arancio
 -  **80 124 368** / 2 travette
e 4 ruote
-  **Prodotto Personalizzabile**



Cargopallet 300 Plus



Codice Prodotto

-  **80 124 150** / 4 piedi
 -  **80 124 151** / 2 travette
 -  **80 124 152** / 4 ruote
 -  **80 124 157** / 2 travette
e 4 ruote
 -  **80 124 180** / 4 piedi
 -  **80 124 181** / 2 travette
 -  **80 124 182** / 4 ruote
 -  **80 124 185** / 2 travette
e 4 ruote
-  **Prodotto Personalizzabile**



Dati Tecnici

Cargopallet 300 Plus

Dim. esterne	Dim. interne	Dim. est. con ruote ali angoli	Peso	Incasto impilabilità	Luce tra i piedi	Altezza dei piedi	Capacità max	Portata max	Portata max in sovrapp.
1000x 700x h650	940x 640x h500	1000x 700x h800	14,4 Kg (80 124 150)	35	lato corto 505 lato lungo 640	120	297 dm ³	300 kg	1200 kg

CARGOPALLET 700 PRODOTTI PERICOLOSI SOLIDI

I Cargopallet 300/600 New/700 Plus, sono realizzati nel pieno rispetto della normativa ADR e sono adatti per il trasporto e stoccaggio terrestre e ferroviario dei prodotti pericolosi solidi (UN 2794, UN 2795, UN 2800, UN 3028). Il Cargopallet 600 New per Prodotti Pericolosi Solidi è omologato anche al trasporto e stoccaggio di batterie al litio (UN 3091).

The Cargopallet 300/600 New/700 Plus, are manufactured in full compliance with the ADR regulations and are suitable for transporting and storing terrestrial and railway solid hazardous products (UN 2794, UN 2795, UN 2800, UN 3028). The 600 New Cargopallet for Solid Hazardous Products is also used for the transportation and storage of lithium batteries (UN 3091).

Cargopallet 700 Prodotti Pericolosi Solidi



Codice Prodotto



80 124 870 / 3 travette



Batterie Esauste / Low Battery



Cargopallet 600 New Prodotti Pericolosi Solidi



Codice Prodotto



30 185 743 N / 2 travette



Batterie Esauste / Low Battery



Batterie al Litio / Lithium Battery



Cargopallet 300 Prodotti Pericolosi Solidi



Codice Prodotto



80 124 162 / 2 travette



Batterie Esauste / Low Battery



Cargopallet 700 Prodotti Pericolosi Solidi

Dati Tecnici

Dim. esterne	Dim. interne	Peso	Incasso impilabilità	Luce tra i piedi	Altezza dei piedi	Capacità max	Portata max	Portata max in sovrapp.
1200x1000xh830	1120x920xh655	38,3 Kg	20	lato corto 800 lato lungo 830	120	680 dm ³	500 kg	1500 kg

Cargopallet 600 New Prodotti Pericolosi Solidi

Dati Tecnici

Dim. esterne	Dim. interne	Peso	Incasso impilabilità	Luce tra i piedi	Altezza dei piedi	Capacità max	Portata max	Portata max in sovrapp.
1200x800xh850	1130x725xh690	30,6 Kg	35	lato corto 600 lato lungo 830	120	550 dm ³	500 kg	1500 kg

Cargopallet 300 Prodotti Pericolosi Solidi

Dati Tecnici

Dim. esterne	Dim. interne	Peso	Incasso impilabilità	Luce tra i piedi	Altezza dei piedi	Capacità max	Portata max	Portata max in sovrapp.
1000x700xh650	940x640xh500	19,2 Kg	35	lato corto 505 lato lungo 640	120	297 dm ³	300 kg	900 kg

GRANDI CONTENITORI / LARGE CONTAINERS

LOGISTICA E MOVIMENTAZIONE / LOGISTICS AND HANDLING

CARGOPALLET PLUS

1300 / 1100 PLUS NEW



Dotabile di porta-etichetta, piedi, travette e ruote. Disponibile anche nella versione per alimenti, non è adatto ai liquidi.

Not suitable for liquids. Also available for foodstuffs. Fitted with feet, runners or wheels.

Cargopallet 1300 Plus



Codice Prodotto









-  **80 124 901** / 4 piedi
 -  **80 124 902** / 2 travette
 -  **80 124 903** / 3 travette
 -  **80 124 919** / 4 piedi e portello
 -  **80 124 911** / 4 piedi
 -  **80 124 912** / 2 travette
 -  **80 124 913** / 3 travette
 -  **80 124 916** / 4 piedi e portello
-  **Prodotto Personalizzabile**



Cargopallet 1100 Plus New



Codice Prodotto

-  **30 185 835 N** / 4 piedi
 -  **30 185 836 N** / 2 travette
 -  **30 185 837 N** / 4 travette
 -  **30 185 838 N** / 4 piedi e portello
 -  **30 185 820 N** / 4 piedi
 -  **30 185 830 N** / 2 travette
 -  **30 185 831 N** / 4 travette
 -  **30 185 827 N** / 4 piedi e portello
-  **Prodotto Personalizzabile**



Dati Tecnici

Cargopallet 1300/1100 Plus New

* Dimensioni del portello 782x40xh326

Prodotto	Dim. esterne	Dim. interne	Peso	Incasso impilabilità	Luce tra i piedi	Altezza dei piedi	Capacità max
Cargopallet 1300	1200x1000xh1450	1120x920xh1270	51,0 Kg (80 124 901)	20	lato corto 800 lato lungo 830	120	1300 dm ³
Cargopallet 1100 Plus New	1200x800xh1510	1130x725xh1350	42,5 Kg (30 185 835 N)	35	lato corto 600 lato lungo 830	120	1100 dm ³

280





Il Cargopallet 280 è studiato e realizzato per lo stoccaggio ed il trasporto di generi alimentari. Portata fino a 150 Kg di prodotto senza deformazione del fondo.

The Cargopallet 280 has been designed to store and to transport food and vegetables. It can be loaded up to 150 Kg with no bottom deformation.

Cargopallet 280



Codice Prodotto

-  **80 124 600**
-  **80 124 601 / 4 piedi**
-  **80 124 602 / 4 ruote**
-  **Prodotto Personalizzabile**



Dati Tecnici

Dim. esterne	Dim. interne	Dim. esterne con piedi	Dim. esterne con ruote	Peso	Luce tra i piedi	Altezza dei piedi	Portata max	Portata max in sovrapp.
1200x 1000x h234	1129x 929x h195	1200x 1000x h350	1200x 1000x h500	12,2 Kg (80 124 600)	lato corto 590 lato lungo 790	100	150 kg	1500 Kg

COPERCHI

Scegliete il coperchio più congeniale per completare il vostro Cargopallet.

To complete your Cargopallet you can select the most suitable lid.

I Coperchi



Coperchio 300



Coperchi 600/1100



Coperchio 600 con portello



Coperchi 700/1300







Coperchio 700 con portello

Codice Prodotto





Coperchio 300

-  **30 194 650**  **30 194 680**
-  **30 194 652 / maniglia**  **30 194 682 / maniglia**

Coperchi 600/1100

-  **30 194 639**  **30 194 637**
-  **30 194 634 / maniglia**  **30 194 633 / maniglia**

Coperchio 600 con portello

-  **30 194 642**  **30 194 643**
-  **30 194 644 / maniglia**  **30 194 645 / maniglia**

Coperchi 700/1300

-  **30 194 700**  **30 194 705**
-  **30 194 701 / maniglia**  **30 194 706 / maniglia**

Coperchio 700 con portello

-  **30 194 710**  **30 194 715**
-  **30 194 711 / maniglia**  **30 194 716 / maniglia**

Dati Tecnici

Coperchio 300	Coperchi 600/1100	Coperchio 600 con portello	Coperchi 700/1300	Coperchi 700 con portello
Dimensioni Esterne 1020x720xh30/65	Dimensioni Esterne 1215x815xh30/65	Dimensioni Esterne 1215x815xh30/65	Dimensioni Esterne 1216x1014xh30/65	Dimensioni Esterne 1216x1014xh30/65

ACCESSORI

Scegliete l'accessorio più congeniale per completare il vostro Cargopallet.

To complete your Cargopallet you can select the most suitable accessory.

Accessori



Rubinetto a sfera



Tappo a vite



Portaetichette
per 300-600-700-1100-1300



Portadocumenti A4/A5
per cargo



Travette



Ruota standard



Ruota speciale



Traversina con ruote

Codice Prodotto

Rubinetto a sfera

80 466 001 / Utile in caso stoccaggio liquidi

Tappo a vite

80 466 002 / Realizzato in resina

Portaetichette per 300-600-700-1100-1300

30 005 633 / 165x120xh1,5

Portadocumenti A4/A5 per cargo

30 005 650A / 295x215xh10

Travette

Per l'utilizzo di carrelli elevatori con forche rotanti

Ruota standard

Per carichi inferiori ai 400 Kg. (*Freno su richiesta*)

Ruota speciale

Per carichi superiori ai 400 Kg. (*Freno su richiesta*)

Travette con ruote

Per agevolare lo spostamento dei cargopallet senza l'ausilio di carrelli elevatori. (*Freno su richiesta*)

CARGO FOLD 700







Cargo Fold 700, ideale per risolvere la logistica del ritorno degli imballi grazie al notevole risparmio di spazio quando è ripiegato. Disponibile anche con ruote.

Cargo Fold 700, the best product when the logistic calls for packaging return thanks to the considerable space saving when folded. It is also available with wheels.

Cargo Fold 700



Codice Prodotto









-  **80 124 701** / 4 piedi
-  **80 124 702** / 2 travette
-  **80 124 703** / 3 travette
-  **80 124 705** / 4 ruote
-  **80 124 721** / 4 piedi
-  **80 124 722** / 2 travette
-  **80 124 723** / 3 travette
-  **80 124 725** / 4 ruote
-  **Prodotto Personalizzabile**



Cargo Fold 700 con Portello



Codice Prodotto

-  **80 124 711** / 4 piedi
-  **80 124 712** / 2 travette
-  **80 124 713** / 3 travette
-  **80 124 715** / 4 ruote
-  **80 124 731** / 4 piedi
-  **80 124 732** / 2 travette
-  **80 124 733** / 3 travette
-  **80 124 735** / 4 ruote
-  **Prodotto Personalizzabile**

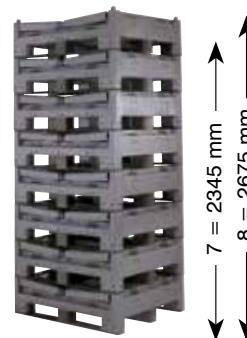

Ripiegato risparmio del 63% del volume
Folded 63% less volume

Dati Tecnici









* Dimensioni del portello 782x40xh326

Dim. esterne	Dim. interne	Dim. est. con ruote	Peso	Cont. chiuso	Incasto impilabilità	Luce tra i piedi	Altezza dei piedi	Capacità max	Portata max	Portata max in sovrapp.
1200x 1000x h847	1120x 920x h654	1220x 1000x h854	36,0 Kg (80 124 701)	h 365	35	lato corto 800 lato lungo 830	120	650 dm ³	600 kg Cargo 700 Fold / 3 travi	2400 Kg

Cargo Fold 700 Grigliato



Codice Prodotto

-  80 124 751 / 4 piedi
-  80 124 752 / 2 travette
-  80 124 753 / 3 travette
-  80 124 755 / 4 ruote
-  80 124 771 / 4 piedi
-  80 124 772 / 2 travette
-  80 124 773 / 3 travette
-  80 124 775 / 4 ruote
-  Prodotto Personalizzabile











Cargo Fold 700 Grigliato con Portello

VENDITA LEGATA A QUANTITATIVI MINIMI



Codice Prodotto

-  80 124 761 / 4 piedi
-  80 124 762 / 2 travette
-  80 124 763 / 3 travette
-  80 124 765 / 4 ruote
-  80 124 781 / 4 piedi
-  80 124 782 / 2 travette
-  80 124 783 / 3 travette
-  80 124 785 / 4 ruote
-  Prodotto Personalizzabile



Dati Tecnici

* Dimensioni del portello 782x40xh326

Dim. esterne	Dim. interne	Dim. est. con ruote	Peso	Cont. chiuso	Incasto impilabilità	Luce tra i piedi	Altezza dei piedi	Capacità max	Portata max	Portata max in sovrapp.
1200x1000xh847	1120x920xh654	1220x1000xh854	34,3 Kg (80 124 751)	h 365	35	lato corto 800 lato lungo 830	120	650 dm ³	600 kg Cargo 700 Fold / 3 travi	2400 Kg

CONTENITORI MULTIUSO

Organizzazione perfetta, stoccaggio ottimale

MULTIPLE USE CONTAINERS

Perfect organization, optimum storage

Questa vasta famiglia di contenitori assicura la massima versatilità di utilizzo, con soluzioni ad hoc per specifiche necessità di movimentazione e stoccaggio.

This extensive family of containers ensures maximum versatility in use, with proper solutions for specific requirements as handling and storing.



Alfa

Delta

Delta Mec

Delta Mec Fold

Delta Mec 60L / Delta Mec 70 Open

Delta Mec Misure Speciali

Pettini e Divisori

Coperchi e accessori Delta Mec

Omikron

Tauxi

Tau

Cassonetti Carrellati

Jota

Lambda

Contenitori isothermici

Gamma

Cestelli



CONTENITORI MULTIUSO / MULTIPLE USE CONTAINERS

ORGANIZZAZIONE E STOCCAGGIO / ORGANIZATION AND STORAGE

COMPONIBILI AUTOPORTANTI

ALFA

Contenitori multicomponibili autoportanti a bocca di lupo, ideali per il prelievo manuale del contenuto nei magazzini e nelle catene di montaggio.

Self-supporting multiple use containers, the open side is ideal for the manual picking of the goods in the workshops and on assembly lines.

Alfa 1



Codice Prodotto

 30 185 200

Dimensioni esterne	Dimensioni interne	Peso
102x88xh50	90x78xh42	 0,037 Kg



Alfa 2





Codice Prodotto

 30 185 220

 30 185 224

 30 185 226

 30 185 229

Dimensioni esterne	Dimensioni interne	Peso
103x173xh74	85x147xh65	 0,095 Kg



Alfa 3



Codice Prodotto

 30 185 240

 30 185 244

 30 185 246

 30 185 250

Dimensioni esterne	Dimensioni interne	Peso
144x235xh116	123x203xh103	 0,24 Kg



CONTENITORI MULTIUSO / MULTIPLE USE CONTAINERS



ORGANIZZAZIONE E STOCCAGGIO / ORGANIZATION AND STORAGE

COMPONIBILI AUTOPORTANTI

Alfa 4



Codice Prodotto

-  30 185 260
-  30 185 264
-  30 185 266
-  30 185 270





Dimensioni esterne	Dimensioni interne	Peso
207x335xh150	178x290xh138	 0,43 Kg



Alfa 5



Codice Prodotto

-  30 185 280
-  30 185 284
-  30 185 286
-  30 185 292
-  30 185 288



Dimensioni esterne	Dimensioni interne	Peso
307x480xh185	275x430xh170	 1,18 Kg



Alfa 5 Bis



Codice Prodotto

-  30 185 300
-  30 185 308

Dimensioni esterne	Dimensioni interne	Peso
307x480xh185	275x430xh170	 1,48 Kg



CONTENITORI MULTIUSO / MULTIPLE USE CONTAINERS

ORGANIZZAZIONE E STOCCAGGIO / ORGANIZATION AND STORAGE

COMPONIBILI AUTOPORTANTI

Alfa 6



Codice Prodotto

 30 185 320

 30 185 324

Dimensioni esterne	Dimensioni interne	Peso
437x570xh247	397x510xh228	 2,08 Kg





Alfa 6 Bis



Codice Prodotto

 30 185 330

 30 185 334

Dimensioni esterne	Dimensioni interne	Peso
437x570xh247	397x510xh228	 2,43 Kg





Alfa 7



Codice Prodotto

 30 185 340

 30 185 344

Dimensioni esterne	Dimensioni interne	Peso
437x700xh301	397x640xh280	 2,7 Kg



CONTENITORI MULTIUSO / MULTIPLE USE CONTAINERS

ORGANIZZAZIONE E STOCCAGGIO / ORGANIZATION AND STORAGE

COMPONIBILI AUTOPORTANTI

Alfa 7 Bis



Codice Prodotto

 30 185 350

 30 185 354

Dimensioni esterne	Dimensioni interne	Peso
437x700xh301	397x640xh280	 3,7 Kg



ACCESSORI ALFA

Per i modelli ALFA 5, 5 bis, 6, 6 bis, 7, 7 bis sono disponibili specifici carrelli per agevolare la movimentazione.

Alfa Accessories. Specific trolleys are available for the ALFA 5, 5 bis, 6, 6 bis, 7, 7 bis models.

Accessori



Carrelli



Etichette



Barra Rack

Codice Prodotto

Carrelli

30 130 510 / Alfa 5 e 5 Bis per 2 contenitori 615x440xh185

30 130 512 / Alfa 6 e 6 Bis per 2 contenitori 880x485xh185

30 130 514 / Alfa 7 e 7 Bis per 2 contenitori 880x610xh185

Etichette

30 838 60x / Alfa 2 foglio da 50 etichette

30 838 61x / Alfa 3, 4, 5, 5 Bis foglio da 21 etichette

30 838 62x / Alfa 6, 6 Bis, 7, 7 Bis foglio da 7 etichette

Barra Rack

30 827 501 / Senza contenitori 930x200xh10

CONTENITORI MULTIUSO / MULTIPLE USE CONTAINERS

ORGANIZZAZIONE E STOCCAGGIO / ORGANIZATION AND STORAGE

SOVRAPPONIBILI

DELTA





Contenitori sovrapponibili, con maniglie, adatti a minuteria meccanica e prodotti farmaceutici. Anche in materiale atossico o in materiale conduttivo.



Stackable containers with handles, suitable for small metal products and pharmaceuticals. Also available in non-toxic material or in conductive plastic.

Delta 20



Codice Prodotto

-  30 185 400
-  30 185 406
-  30 185 403
-  Prodotto Personalizzabile

Dimensioni esterne	Dimensioni interne	Peso
447x314xh200	375x275xh195	 1,13 Kg
		 1,24 Kg





Delta 21



Codice Prodotto

-  30 185 410
-  Prodotto Personalizzabile
-  30 185 416

Dimensioni esterne	Dimensioni interne	Peso
400x300xh257	325x260xh254	 1,3 Kg
		 1,38 Kg





Delta 30



Codice Prodotto

-  30 185 420
-  Prodotto Personalizzabile
-  30 185 423

Dimensioni esterne	Dimensioni interne	Peso
510x415xh195	440x375xh190	 1,43 Kg
		 1,5 Kg



CONTENITORI MULTIUSO / MULTIPLE USE CONTAINERS

ORGANIZZAZIONE E STOCCAGGIO / ORGANIZATION AND STORAGE

SOVRAPPONIBILI

Delta 60



Codice Prodotto





30 185 440



Prodotto Personalizzabile



30 185 443

Dimensioni esterne	Dimensioni interne	Peso
610x425xh300	535x365xh290	 2,54 Kg
		 2,84 Kg



ACCESSORI DELTA

Accessori



Carrelli



Coperchi



Portaetichette



Codice Prodotto

Carrelli

30 130 530 / Delta 20 410x315xh125

30 130 532 / Delta 21 360x300xh125

30 130 535 / Delta 30 460x395xh125

30 130 538 / Delta 60 590x420xh180

Coperchi

 32 194 730 / Delta 20 457x320xh25

 32 194 740 / Delta 30 515x420xh20

 32 194 750 / Delta 60 610x435xh20

 30 194 607 / Delta 21 408x310xh15

Portaetichette

 30 005 631 / 195x5xh100

 30 005 632 / 195x5xh100

CONTENITORI MULTIUSO / MULTIPLE USE CONTAINERS

ORGANIZZAZIONE E STOCCAGGIO / ORGANIZATION AND STORAGE

SOVRAPPONIBILI

MINI DELTA MEC 300x200

Contenitori sovrapponibili utilizzati nei processi di movimentazione e stoccaggio nell'industria orafa e per il trasporto di materiali e componenti preziosi e/o delicati. Coperchio a slitta sigillabile.

Stackable bins. They are particularly suitable for the gold and precious materials handling. Sliding and sealable lid.

Mini Delta Mec 90



Codice Prodotto



80 230 260



Prodotto Personalizzabile



Mini Delta Mec 120



Codice Prodotto



80 230 261



Prodotto Personalizzabile



Dati Tecnici

Pareti piene, fondo pieno, maniglie chiuse, coperchio a slitta sigillabile.

Prodotto	Dimensioni esterne	Dimensioni interne	Peso
Mini Delta Mec 90	300x200xh90	265x165xh85	0,335 Kg
Mini Delta Mec 120	300x200xh120	265x165xh115	0,355 Kg

CONTENITORI MULTIUSO / MULTIPLE USE CONTAINERS

ORGANIZZAZIONE E STOCCAGGIO / ORGANIZATION AND STORAGE

SOVRAPPONIBILI

Mini Delta Mec 140



Codice Prodotto



80 230 262



Prodotto Personalizzabile



Mini Delta Mec 170



Codice Prodotto



80 230 263



Prodotto Personalizzabile



Mini Delta Mec 220



Codice Prodotto



80 230 264



Prodotto Personalizzabile



Dati Tecnici

Pareti piene, fondo pieno, maniglie chiuse, coperchio a slitta sigillabile.

Prodotto	Dimensioni esterne	Dimensioni interne	Peso
Mini Delta Mec 140	300x200xh140	265x165xh135	0,410 Kg
Mini Delta Mec 170	300x200xh170	265x165xh165	0,445 Kg
Mini Delta Mec 220	300x200xh220	265x165xh215	0,555 Kg

CONTENITORI MULTIUSO / MULTIPLE USE CONTAINERS

ORGANIZZAZIONE E STOCCAGGIO / ORGANIZATION AND STORAGE

SOVRAPPONIBILI

DELTA MEC 400x300

Contenitori ultrarobusti, in materiale antiurto inattaccabile da acidi e solventi. Con coperchio in appoggio o a slitta, fondo pieno o alveolare.

Ultra-sturdy containers made of shockproof material inert to acids and solvents and resistant to damp. With a lid that sits on or slides onto the top.

Delta Mec 3



Codice Prodotto



80 230 230



Prodotto Personalizzabile



Delta Mec 6



Codice Prodotto



80 230 240



Prodotto Personalizzabile



Dati Tecnici

Pareti piene, fondo pieno, maniglie chiuse. * Fondo alveolare

Prodotto	Dimensioni esterne	Dimensioni interne	Peso
Delta Mec 3	400x300xh40	365x262xh30	0,475 Kg
Delta Mec 6	400x300xh70	365x262xh60	0,645 Kg

CONTENITORI MULTIUSO / MULTIPLE USE CONTAINERS

ORGANIZZAZIONE E STOCCAGGIO / ORGANIZATION AND STORAGE

SOVRAPPONIBILI

Delta Mec 9



Codice Prodotto

80 230 250

Prodotto Personalizzabile



Delta Mec 12



Codice Prodotto

80 230 051

Prodotto Personalizzabile



Delta Mec 17



Codice Prodotto

80 230 183

Prodotto Personalizzabile



Dati Tecnici

Pareti piene, fondo pieno, maniglie chiuse. * Fondo alveolare

Prodotto	Dimensioni esterne	Dimensioni interne	Peso
Delta Mec 9	400x300xh100	365x262xh90	0,765 Kg
Delta Mec 12*	400x300xh140	365x262xh130	1,0 Kg
Delta Mec 17*	400x300xh170	365x262xh160	1,1 Kg

CONTENITORI MULTIUSO / MULTIPLE USE CONTAINERS

ORGANIZZAZIONE E STOCCAGGIO / ORGANIZATION AND STORAGE

SOVRAPPONIBILI

Delta Mec 22



Codice Prodotto



80 230 182



Prodotto Personalizzabile



Delta Mec 32



Codice Prodotto



80 230 191



Prodotto Personalizzabile



Cornice per Delta Mec 400x300



Codice Prodotto



80 230 223



Prodotto Personalizzabile



Dati Tecnici

Pareti piene, fondo pieno, maniglie chiuse. * Fondo alveolare

Prodotto	Dimensioni esterne	Dimensioni interne	Peso
Delta Mec 22*	400x300xh220	365x262xh210	1,33 Kg
Delta Mec 32*	400x300xh320	365x262xh310	1,71 Kg
Cornice Delta Mec 400x300	400x300xh75	355x255xh75 (altezza utile: 60 mm)	0,37 Kg

CONTENITORI MULTIUSO / MULTIPLE USE CONTAINERS

ORGANIZZAZIONE E STOCCAGGIO / ORGANIZATION AND STORAGE

SOVRAPPONIBILI

DELTA MEC 600x400

Contenitori antiurto, sovrapponibili, con maniglie passanti o chiuse, pareti verticali, sono adatti anche ai magazzini automatici.

Shockproof containers, stackable, with open or closed handles, vertical walls, they are suitable also for automatic warehouses.

Delta Mec 25



Codice Prodotto



80 230 177



Prodotto Personalizzabile



Delta Mec 30



Codice Prodotto



80 230 075



Prodotto Personalizzabile



Dati Tecnici

Pareti piene, fondo alveolare, maniglie chiuse.

Prodotto	Dimensioni esterne	Dimensioni interne	Peso
Delta Mec 25	600x400xh140	565x360xh130	1,55 Kg
Delta Mec 30	600x400xh170	565x360xh160	1,87 Kg

CONTENITORI MULTIUSO / MULTIPLE USE CONTAINERS

ORGANIZZAZIONE E STOCCAGGIO / ORGANIZATION AND STORAGE

SOVRAPPONIBILI

Delta Mec 35



Codice Prodotto



80 230 077



Prodotto Personalizzabile



Delta Mec 40



Codice Prodotto



80 230 079



Prodotto Personalizzabile



Delta Mec 45



Codice Prodotto



80 230 081



Prodotto Personalizzabile



Dati Tecnici

Pareti piene, fondo alveolare, maniglie chiuse.

Prodotto	Dimensioni esterne	Dimensioni interne	Peso
Delta Mec 35	600x400xh200	565x360xh190	2,035 Kg
Delta Mec 40	600x400xh220	565x360xh210	2,035 Kg
Delta Mec 45	600x400xh240	565x360xh230	2,175 Kg

CONTENITORI MULTIUSO / MULTIPLE USE CONTAINERS

ORGANIZZAZIONE E STOCCAGGIO / ORGANIZATION AND STORAGE

SOVRAPPONIBILI

Delta Mec 50



Codice Prodotto



80 230 083



Prodotto Personalizzabile



Delta Mec 60



Codice Prodotto



80 230 132



Prodotto Personalizzabile



Delta Mec 70



Codice Prodotto



80 230 210



80 230 207 / con fori di drenaggio



Prodotto Personalizzabile



Dati Tecnici

Pareti piene, fondo alveolare, maniglie chiuse. * Con maniglie passanti

Prodotto	Dimensioni esterne	Dimensioni interne	Peso
Delta Mec 50	600x400xh275	565x360xh265	2,01 Kg
Delta Mec 60	600x400xh320	565x360xh310	2,55 Kg
Delta Mec 70*	600x400xh400	565x360xh390	3,24 Kg

CONTENITORI MULTIUSO / MULTIPLE USE CONTAINERS

ORGANIZZAZIONE E STOCCAGGIO / ORGANIZATION AND STORAGE

SOVRAPPONIBILI

DELTA MEC FOLD

I contenitori Delta Mec Fold sono ideali nella logistica e nel trasporto con ritorno dei vuoti.

Facili da aprire e richiudere, sono disponibili in otto diverse versioni con fondo liscio o rinforzato e con coperchio integrato.

Shockproof containers, stackable, with open or closed handles, vertical walls, they are suitable also for automatic warehouses.

Delta Mec Fold 40



Codice Prodotto

- 83 230 001 / Fondo liscio
- 83 230 002 / Fondo liscio e coperchio
- 83 230 003 / Fondo rinforzato
- 83 230 004 / Fondo rinforzato e coperchio
- Prodotto Personalizzabile



Delta Mec Fold 60



Codice Prodotto

- 83 230 010 / Fondo liscio
- 83 230 011 / Fondo liscio e coperchio
- 83 230 012 / Fondo rinforzato
- 83 230 013 / Fondo rinforzato e coperchio
- Prodotto Personalizzabile



Dati Tecnici

Prodotto	Dimensioni esterne	Dimensioni interne	Peso
Delta Mec Fold 40	600x400xh223	560x362xh205	2,4 Kg (83 230 002)
Delta Mec Fold 60	600x400xh320	558x362xh304	3,3 Kg (83 230 011)

CONTENITORI MULTIUSO / MULTIPLE USE CONTAINERS

ORGANIZZAZIONE E STOCCAGGIO / ORGANIZATION AND STORAGE

SOVRAPPONIBILI

DELTA MEC 60L

Specifico per impianti automatizzati. Fino a 50 Kg di merce senza deformazioni del fondo, ha maniglie ergonomiche ed è dotato di prese robotizzate.

Specifically designed for automatic installations. Up to 50 Kg with no bottom deformation, has ergonomic handles and is fitted with robotic grips.

Delta Mec 60L



Fondo rinforzato.
Indeformabile e resistente



Le maniglie ergonomiche agevolano gli spostamenti manuali.

Codice Prodotto



80 230 351 / Fondo pieno



80 230 353 / Fondo pieno con fori di drenaggio



80 230 350 / Fondo rinforzato



80 230 352 / Fondo rinforzato con fori di drenaggio



Prodotto Personalizzabile



DELTA MEC
60L



DELTA MEC
70 OPEN

E-SHOP

Scannerizza il QR CODE per accedere direttamente alla pagina ufficiale dello store online.
Scan the QR CODE to directly access the official page of the online store.

DELTA MEC 70 OPEN

Questa versione offre sia la sovrapponibilità e l'adattabilità agli impianti automatizzati che l'accessibilità manuale al contenuto.

This version is stackable and therefore suitable for the automatic installations, and offers as a plus the open side for easy picking of the goods.

Delta Mec 70 Open



Codice Prodotto



80 230 206



80 230 205 / con fori di drenaggio



Prodotto Personalizzabile



Dati Tecnici

* Pareti piene, maniglie chiuse / ** Pareti piene, fondo alveolare, maniglia passante

Prodotto	Dimensioni esterne	Dimensioni interne	Peso
Delta Mec 60 L fondo pieno *	600x400xh320	565x360xh300	2,82 Kg (80 230 351)
Delta Mec 60 L fondo rinforzato *	600x400xh320	565x360xh315	3,45 Kg (80 230 350)
Delta Mec 70 Open **	600x400xh400	565x360xh390	3,22 Kg (80 230 206)

CONTENITORI MULTIUSO / MULTIPLE USE CONTAINERS

ORGANIZZAZIONE E STOCCAGGIO / ORGANIZATION AND STORAGE

SOVRAPPONIBILI

DELTA MEC Misure Speciali

Le speciali dimensioni ampliano le possibilità d'uso della linea Delta Mec.

This product's special dimensions expands the possibilities to use the Delta Mec collection.

Delta Mec Misure Speciali



Delta Mec 75



Delta Mec 80



Delta Mec 85F



Delta Mec 100F



Delta Mec 200F

Codice Prodotto

-  **80 230 301** / Delta Mec 75
-  **80 230 310** / Delta Mec 80
-  **30 185 054** / Delta Mec 100F
-  **30 185 055** / Delta Mec 200F
-  **30 185 056** / Delta Mec 85F
-  **Prodotto Personalizzabile**



Dati Tecnici

* Pareti forate, fondo forato, maniglie passanti. ** Pareti chiuse, fondo rinforzato, maniglie passanti.

Prodotto	Dimensioni esterne	Dimensioni interne	Peso
Delta Mec 75 *	600x500 h250	570x470xh245	3,0 Kg
Delta Mec 80 *	610x520 h260	580x490xh255	3,1 Kg
Delta Mec 85F **	820x620 h170	785/791x585/591xh150	3,8 Kg
Delta Mec 100F **	620x420 h400	585/590x385/390xh380	3,65 Kg
Delta Mec 200F **	820x620 h400	785/790x585/591xh380	6,25 Kg

PETTINI e DIVISORI

Ottimizzano lo stoccaggio della serie Delta Mec. Il volume interno di carico può essere ripartito in vani di diverse dimensioni.

Combs dividers. Optimize the storage of the Delta Mec containers series. The inner volume can be organized into compartments.

Pettini e Divisori

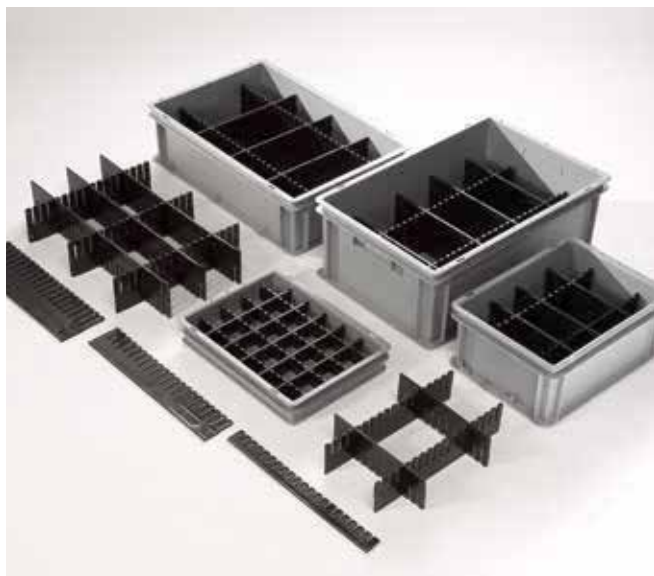

Codice Prodotto

Pettini divisori

- 32 194 400** interno 1150x5 h40
- 32 194 401** interno 1150x5 h80
- 32 194 402** interno 1150x5 h100
- 32 194 403** interno 1150x5 h120
- 32 194 404** interno 1150x5 h180
- 32 194 431** per Mini Delta Mec 300x200 / 160x5 h40
- 32 194 432** per Mini Delta Mec 300x200 / 160x5 h80
- 32 194 433** per Mini Delta Mec 300x200 / 160x5 h100
- 32 194 434** per Mini Delta Mec 300x200 / 160x5 h120
- 32 194 435** per Mini Delta Mec 300x200 / 160x5 h180
- 32 194 410** per Mini Delta Mec 300x200 e 400x300 / 260x5 h40
- 32 194 411** per Delta Mec 400x300 e 600x400 / 360x5 h40
- 32 194 412** per Delta Mec 600x400 / 560x5 h40
- 32 194 413** per Mini Delta Mec 300x200 e 400x300 / 260x5 h80
- 32 194 414** per Delta Mec 400x300 e 600x400 / 360x5 h80
- 32 194 415** per Delta Mec 600x400 / 560x5 h80
- 32 194 416** per Mini Delta Mec 300x200 e 400x300 / 260x5 h100
- 32 194 417** per Delta Mec 400x300 e 600x400 / 360x5 h100
- 32 194 418** per Delta Mec 600x400 / 560x5 h100
- 32 194 419** per Mini Delta Mec 300x200 e 400x300 / 260x5 h120
- 32 194 420** per Delta Mec 400x300 e 600x400 / 360x5 h120
- 32 194 421** per Delta Mec 600x400 / 560x5 h120
- 32 194 429** per Mini Delta Mec 300x200 e 400x300 / 260x5 h180
- 32 194 427** per Delta Mec 400x300 e 600x400 / 360x5 h180
- 32 194 428** per Delta Mec 600x400 / 560x5 h180
- 32 194 406** per Delta Mec / 420x5xh300
- 32 194 407** per Delta Mec / 620x5x300 e 820x5x300
- 32 194 408** per Delta Mec / 820x5x300

Ripiani separatori

- 32 194 425** / per Delta Mec 400x300
- 32 194 426** / per Delta Mec 600x400

CONTENITORI MULTIUSO / MULTIPLE USE CONTAINERS

ORGANIZZAZIONE E STOCCAGGIO / ORGANIZATION AND STORAGE

SOVRAPPONIBILI E IMPILABILI

COPERCHI / ACCESSORI e VARIANTI FONDI

Coperchi e Accessori



Coperchio Mini Delta Mec 300x200



Coperchio Delta Mec 400x300



Coperchio Delta Mec 600x400



Coperchio
Delta Mec 400x300 / 600x400



Carrello per Delta Mec



Portadocumenti A4/A5
Delta Mec 600x400 h400



Portaticchette



Vaschette portaposate

Codice Prodotto

Mini Delta Mec 300x200

 **30 194 609** / 308x210 h19 a slitta sigillabile

Delta Mec 400x300

 **30 194 601** / 400x300xh22

 **30 194 607** / 408x310 h19 a slitta sigillabile

 **30 194 601AI** / 400x300xh22 con cerniere integrate

Delta Mec 600x400

 **30 194 605** / 600x400xh21

 **30 194 618** / 604x407xh19 a slitta sigillabile

 **30 194 605AI** / 600x400xh21 con cerniere integrate

Per Delta Mec 400x300 / 600x400

30 194 647 / sistema di chiusura a mezzo di 2 mollette, non montano

30 005 648 / sistema di chiusura a mezzo di 2 mollette, montano

Carrello per Delta Mec

32 130 585 / 620x420xh170
Utilizzabile per 1 Delta Mec 600x400
o per 2 Delta Mec 400x300

Portadocumenti A4/A5 Delta Mec 600x400 h400

30 005 650A / 295x215xh10

Portaticchette

30 005 638 / 150x7xh85 per Delta Mec 12/70

Vaschette portaposate

53 190 500 / 264x90 h60 vaschetta

53 190 600 / 85x2xh54 separatore

Varianti Fondi



Fondo forato
Per aerazione interna



Fondo pieno
Per i modelli più piccoli

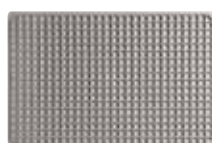

Fondo alveolare
Indeformabile e resistente



**Per Delta Mec 60L
Fondo liscio**
Igienico e anitrumore

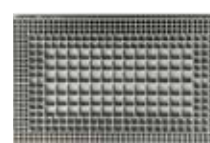

**Per Delta Mec 60L
Fondo rinforzato**
Per carichi gravosi

CONTENITORI MULTIUSO / MULTIPLE USE CONTAINERS

ORGANIZZAZIONE E STOCCAGGIO / ORGANIZATION AND STORAGE

SOVRAPPONIBILI E IMPILABILI

OMIKRON

Contenitori adatti alla movimentazione ed allo stoccaggio. Resistenti a temperature tra -10°C e 100°C. Sono inseribili e vuoti riducono gli ingombri.

Containers suitable for handling and storing. Resistant to temperatures from -10°C to 100°C. They are nestable and when empty occupy less space.

Omikron 6



Codice Prodotto

● 30 185 600



Omikron 70



Codice Prodotto

● 30 185 610 / senza alette

● 30 185 620 / con alette

● 30 185 611 / senza alette

● 30 185 621 / con alette



Dati Tecnici

Prodotto	Dimensioni esterne	Dimensioni interne	Peso
Omikron 6	300x200xh165	230/260x130/160xh160	0,385 Kg
Omikron 70	600x400xh410	490/525x325/350xh405	2,915 Kg (30 185 610)

CONTENITORI MULTIUSO / MULTIPLE USE CONTAINERS



ORGANIZZAZIONE E STOCCAGGIO / ORGANIZATION AND STORAGE

SOVRAPPONIBILI E IMPILABILI

Omikron 100



Codice Prodotto

-  **30 185 630** / senza alette
-  **30 185 640** / con alette
-  **30 185 631** / senza alette
-  **30 185 641** / con alette



Omikron 120



Codice Prodotto

-  **30 185 670**



Omikron 200



Codice Prodotto

-  **30 185 650** / senza alette
-  **30 185 660** / con alette
-  **30 185 652** / senza alette
-  **30 185 662** / con alette

7 Omikron 200 L
sovrapposti
= 3820 mm

7 Omikron 200 L
inseriti
= 1525 mm

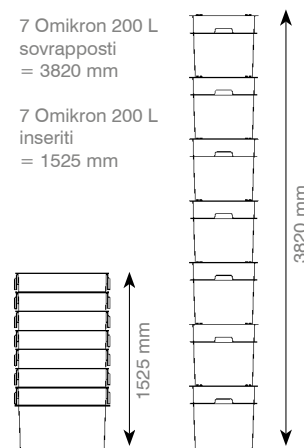

Dati Tecnici

Prodotto	Dimensioni esterne	Dimensioni interne	Peso
Omikron 100	800x400xh410	700/730x325/350xh405	3,12 Kg (30 185 630)
Omikron 120	780x375xh560	695/735x280/315xh555	5,1 Kg
Omikron 200	800x600xh550	675/730x490/540xh545	7,6 Kg (30 185 650)

CONTENITORI MULTIUSO / MULTIPLE USE CONTAINERS

ORGANIZZAZIONE E STOCCAGGIO / ORGANIZATION AND STORAGE

ACCESSORI

Coperchi



Codice Prodotto

-  **30 194 615** / Omikron 6 a slitta sigillabile / 305x205 h20
-  **30 194 610** / Omikron 70 / 610x410xh16
-  **30 194 611** / Omikron 70 / 610x410xh16
-  **30 194 620** / Omikron 100 / 810x410xh20
-  **30 194 621** / Omikron 100 / 810x410xh20
-  **30 194 630** / Omikron 200 / 805x615xh45
-  **30 194 631** / Omikron 200 / 805x615xh45



Sistema di chiusura

30 005 640 / Per coperchi Omikron 70/100

Alette



Codice Prodotto

-  **30 005 030** / Omikron 70/100 395x108xh20
-  **30 005 040** / Omikron 200 595x152xh25

Carrelli



Codice Prodotto

- 30 130 551** / Omikron 70 / 520x350xh185
- 30 130 554** / Omikron 100 / 725x350xh185
- 30 130 557** / Omikron 200 / 710x515xh185

CONTENITORI MULTIUSO / MULTIPLE USE CONTAINERS

ORGANIZZAZIONE E STOCCAGGIO / ORGANIZATION AND STORAGE

SOVRAPPONIBILI E IMPILABILI

TAUXI

I contenitori TAUXI sono ideali per la distribuzione organizzata. Con coperchio a “coccodrillo”, sono disponibili in tre diverse misure. Inseribili a coperchio aperto e sovrapponibili a coperchio chiuso.

TAUXI Containers are ideal for retail chains. They are equipped with a “crocodile” lid and are available in three different sizes. They are nestable with the open lid and stackable with the closed lid.

Tauxi 46



Codice Prodotto

32 185 550

5 Tauxi 46 sovrapposti = 1265 mm
5 Tauxi 46 inseriti = 590 mm

Prodotto Personalizzabile

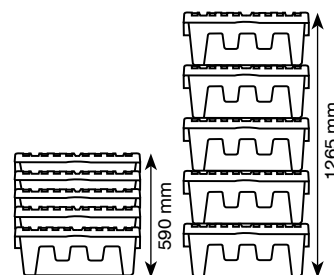

Tauxi 54



Codice Prodotto

32 185 551

5 Tauxi 54 sovrapposti = 1515 mm
5 Tauxi 54 inseriti = 700 mm

Prodotto Personalizzabile

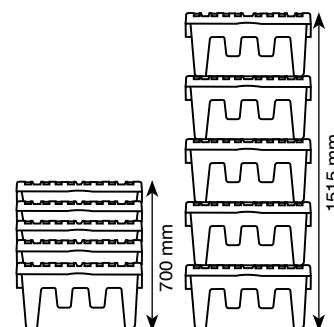

Tauxi 67



Codice Prodotto

32 185 552

5 Tauxi 67 sovrapposti = 1765 mm
5 Tauxi 67 inseriti = 830 mm

Prodotto Personalizzabile

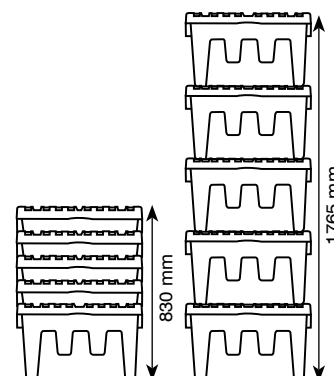

Dati Tecnici

Prodotto	Dimensioni esterne	Dimensioni interne	Peso
Tauxi 46	600x400xh265	547x365xh237	2,95 Kg
Tauxi 54	600x400xh315	547x365xh287	3,3 Kg
Tauxi 67	600x400xh365	547x365xh337	3,6 Kg

CONTENITORI MULTIUSO / MULTIPLE USE CONTAINERS

ORGANIZZAZIONE E STOCCAGGIO / ORGANIZATION AND STORAGE

SOVRAPPONIBILI E IMPILABILI

TAU

Sovrapponibili e impilabili se ruotati di 180°, agevolano lo stoccaggio dei vuoti. Sono perfetti per giornali e riviste e per prodotti farmaceutici.

They are stackable and nestable when spun by 180°, thus easing the empties storage. They are perfect for news papers and for pharmaceutical products.

Tau 27



Codice Prodotto



30 185 544



Prodotto Personalizzabile



Coperchio Tau 27



30 194 604

465x350xh18



Tau 40



Codice Prodotto



30 185 547



Prodotto Personalizzabile



Coperchio Tau 40



30 194 625

560x390xh30

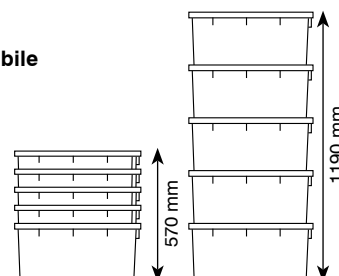

5 Tau 40 sovrapposti = 1190 mm
5 Tau 40 inseriti = 570 mm

Dati Tecnici

Prodotto	Dimensioni esterne	Dimensioni interne	Peso
Tau 27	460x345xh245	370/390x285/300xh240	1,17 Kg
Tau 40	550x380xh250	435/475x320/345xh245	1,52 Kg

CONTENITORI MULTIUSO / MULTIPLE USE CONTAINERS

ORGANIZZAZIONE E STOCCAGGIO / ORGANIZATION AND STORAGE

SOVRAPPONIBILI E IMPILABILI

Tau 50



Codice Prodotto

30 185 559

Prodotto Personalizzabile



Coperchio Tau 50

30 194 628
610x410xh27

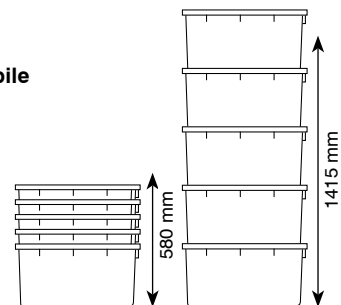

5 Tau 50 sovrapposti = 1415 mm
5 Tau 50 inseriti = 580 mm

Tau 70



Codice Prodotto

30 185 550

Prodotto Personalizzabile

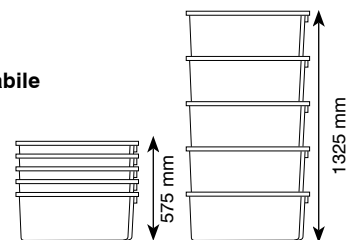

5 Tau 70 sovrapposti = 1325 mm
5 Tau 70 inseriti = 575 mm



Tau 30 Grigliato



Codice Prodotto

30 185 555

Prodotto Personalizzabile



Dati Tecnici

Prodotto	Dimensioni esterne	Dimensioni interne	Peso
Tau 50	600x400xh300	500/535x330/360xh297	2,05 Kg
Tau 70	715x440xh280	600/620x340/365xh275	2,23 Kg
Tau 30 Grigliato	580x395xh175	495x370xh165	1,15 Kg

CONTENITORI MULTIUSO / MULTIPLE USE CONTAINERS

ORGANIZZAZIONE E STOCCAGGIO / ORGANIZATION AND STORAGE

PORTA RIFIUTI

CASSONETTI CARRELLATI

Contenitori per la raccolta differenziata di materiali da riciclo e di rifiuti, disponibili in 6 diversi colori per l'identificazione degli scarti.

Special containers for the waste separate collection, available in six different colours for the identification of the waste.

Cassonetti Carrellati per raccolta differenziata		120 Litri	240 Litri
		<ul style="list-style-type: none"> 80 124 450 80 124 451 80 124 452 80 124 453 80 124 454 80 124 455 	<ul style="list-style-type: none"> 80 124 460 80 124 461 80 124 462 80 124 463 80 124 464 80 124 465
		<p>80 124 459 Reggisacco per cassonetto</p>	
			

Dati Tecnici

Prodotto	Dimensioni esterne	Capacità	Peso
Cassonetti Carrellati da 120 litri	550x500xh940	120 lt	8,15 Kg
Cassonetti Carrellati da 240 litri	720x580xh1060	240 lt	12,5 Kg

CONTENITORI MULTIUSO / MULTIPLE USE CONTAINERS

ORGANIZZAZIONE E STOCCAGGIO / ORGANIZATION AND STORAGE

CESTELLI

JOTA

Cestelli sovrapponibili, in resine atossiche adatte ad usi alimentari. Per il modello Jota 40 è disponibile il carrello metallico.

Stackable baskets made of non-toxic resin, suitable for use with foodstuffs. Jota 40 is also available in a version with a metal trolley.



Jota 40





Carrello per Jota 40



Jota 50

Jota 40

 30 185 104

 30 185 107

Carrello per Jota 40

30 130 580 / 505x335xh185

Jota 50

 80 230 122



Jota 40

Dati Tecnici

Prodotto	Dimensioni esterne	Dimensioni interne	Peso
Jota 40	540x360 h300	495x325Xh280	1,65 Kg (30 185 104)
Jota 50	600x400xh275	565x360xh265	1,595 Kg

CONTENITORI MULTIUSO / MULTIPLE USE CONTAINERS

ORGANIZZAZIONE E STOCCAGGIO / ORGANIZATION AND STORAGE

CESTELLI

LAMBDA

Cestello sovrapponibile, sfrutta gli spazi nei piccoli punti vendita. Con ruote pivotanti e distanziatori per combinazioni multipiano.

Stackable crate, ideal in small points of sale. Available with pivouetting wheels and spacer elements to make multilayer combination.

Lambda



Codice Prodotto

 30 185 123

 30 185 124



Accessori



Codice Prodotto

 30 240 501 / Distanziatore piccolo h20

 30 240 505 / Distanziatore medio h100

 30 240 510 / Distanziatore grande h175

30 756 523 / Ruota h 90



Dati Tecnici

Prodotto	Dimensioni esterne	Dimensioni interne	Peso
Lambda	600x400xh150	550x355xh145	1,05 Kg (30 185 123)

CONTENITORI MULTIUSO / MULTIPLE USE CONTAINERS

ORGANIZZAZIONE E STOCCAGGIO / ORGANIZATION AND STORAGE

USO SPECIFICO

CONTENITORI ISOTERMICI

Ideali per alimenti, contengono vaschette Gastro-norm 1/1 o sottomultipli. In polipropilene espanso, sono igienici, economici e riciclabili al 100%.

Isothermal containers. Ideal for food, they take Gastronorm 1/1 trays or submultiples. Made by expanded PP, they are hygienic and 100% recyclable.

Contenitori Isotermici



Codice Prodotto

Contenitori isotermici 1

● 53 190 800 / Gastronorm gn1/1 h120 mm

Contenitori isotermici 2

● 53 190 801 / Gastronorm gn 1/1 h215 mm

Accessori

53 190 810 / inserto gn ice

53 190 811 / piastra eutectica 2200 cm³



Dati Tecnici

Prodotto	Dimensioni esterne	Peso
Contenitore Isotermico 1	600x400xh185	0,67 Kg
Contenitore Isotermico 2	600x400xh280	0,74 Kg

CONTENITORI MULTIUSO / MULTIPLE USE CONTAINERS

ORGANIZZAZIONE E STOCCAGGIO / ORGANIZATION AND STORAGE

BACINELLE

GAMMA

Bacinelle in materiale atossico, resistente a grassi e agenti chimici. Utili nelle industrie conserviere e nella lavorazione del pesce.

Basins made by non-toxic material, resistant to fats and chemical agents. Useful in the preserves industry and in fish processing.

Gamma 1



Codice Prodotto

 30 185 001

 Prodotto Personalizzabile



Gamma 2



Codice Prodotto

 30 185 002

 Prodotto Personalizzabile



Gamma 3



Codice Prodotto

 30 185 003

 Prodotto Personalizzabile



Dati Tecnici

Prodotto	Dimensioni esterne	Dimensioni interne	Peso
Gamma 1	230x180xh42	193x143xh40	0,098 Kg
Gamma 2	310x250xh65	255x195xh60	0,225 Kg
Gamma 3	370x310xh75	315x255xh70	0,375 Kg

CONTENITORI MULTIUSO / MULTIPLE USE CONTAINERS

ORGANIZZAZIONE E STOCCAGGIO / ORGANIZATION AND STORAGE

BACINELLE

Gamma 4



Codice Prodotto

 30 185 004

 Prodotto Personalizzabile



Gamma 5



Codice Prodotto

 30 185 005

 Prodotto Personalizzabile



Gamma 6



Codice Prodotto

 30 185 006

 Prodotto Personalizzabile



Dati Tecnici

Prodotto	Dimensioni esterne	Dimensioni interne	Peso
Gamma 4	520x420xh120	430x330xh115	0,76 Kg
Gamma 5	634x534xh140	530x430xh135	1,22 Kg
Gamma 6	848x648xh160	730x530xh155	2,125 Kg

CONTENITORI MULTIUSO / MULTIPLE USE CONTAINERS

ORGANIZZAZIONE E STOCCAGGIO / ORGANIZATION AND STORAGE

CESTELLI

PORTABICCHIERI / PORTAPIATTI PORTAPOSATE E ACCESSORI

Portabicchieri. Lavaggio e asciugatura.

Portapiatti. Sicura sistemazione dei piatti.

Cestello vuoto. Per oggetti ingombranti.

Portaposate. Adattabile ai cestelli.

Glasses racks. Perforated anti-chalk.

Dishes rack. Plates are secured safely.

Empty rack. For bulky objects outside.

Cutlery rack. Fits with the racks.

Dati Tecnici

	Cestello per bicchieri e calici 3x3	Cestello per bicchieri e calici 4x4	Cestello per bicchieri e calici 5x5	Cestello per bicchieri e calici 6x6	Cestello per bicchieri e calici 7x7
A / cesta base 500x500 h105	53 190 001	53 190 002	53 190 003	53 190 004	53 190 005
	h fino 85mm				
B / cesta base+top 500x500 h150	53 190 011	53 190 021	53 190 031	53 190 041	53 190 051
	h da 86 a 120 mm				
C1 / cesta base+1intermedio+top 500x500 h195	53 190 012	53 190 022	53 190 032	53 190 042	53 190 052
	h da 121 a 160 mm				
C2 / cesta base+2 intermedi+top 500x500 h240	53 190 013	53 190 023	53 190 033	53 190 043	53 190 053
	h da 161 a 200 mm				
C3 / cesta base+3 intermedi+top 500x500 h285	53 190 014	53 190 024	53 190 034	53 190 044	53 190 054
	h da 201 a 240 mm				
C4 / cesta base+4 intermedi+top 500x500 h330	53 190 015	53 190 025	53 190 035	53 190 045	53 190 055
	h da 241 a 280 mm				
Top finale	500x500 h40				



Top finale per cestelli



Codice Prodotto

Top finale per cestelli 3x3

53 190 201 / Contiene 9 bicchieri Scompato 154x154

Top finale per cestelli 4x4

53 190 202 / Contiene 16 bicchieri Scompato 112x112

Top finale per cestelli 5x5

53 190 203 / Contiene 25 bicchieri Scompato 91x91

Top finale per cestelli 6x6

53 190 204 / Contiene 36 bicchieri Scompato 74x74

Top finale per cestelli 7x7

53 190 205 / Contiene 49 bicchieri Scompato 63x63

Le foto dei prodotti in questo catalogo sono puramente indicative
e potrebbero pertanto non essere perfettamente
rappresentative delle caratteristiche del prodotto.



**CONTENITORI
INDUSTRIALI
IN PLASTICA**

PMC S.R.L.

Via Garibaldi, 58/L 25080 Nuvolento (BS)
tel. Ufficio 3314113340 | info@pmcitaltrade.it | www.pmcitaltrade.it